

Introduction of the Device

This chapter explains how to use the keys and controls, power sources, default system settings and basic operations of your electronic dictionary for the first time. We hope it will be helpful for you to use this device. Please proceed to the following chapters for details of each function in different main menus.

1. Precautions

Data Backup

- All your personal data should be copied to separate printed records. We assume no responsibility for data loss or the causes of improper use, reset device, repairs, defects, battery replacement/failures or any other causes.
- Do not remove the battery, turn the power off or insert/remove the card during data saving to avoid abnormality of the product.

Touch Panel & Display

- Lightly clean the screen with dry, clean and soft cloth (do not use volatile liquid like gasoline) to protect the screen from dust

and being scratched during handwriting.

- Protect the glass-screened product from falling or being squeezed. Use only the stylus that comes with the product, rather than other pens, ballpoint pens, pencils, to protect the screen from being scratched.

Extension Card

- Insert the Micro Secure Digital Card/High Capacity Secure Digital card into the card jack. Turn the power off before inserting/ removing the card, or the memory of the card will be lost and the card will be damaged.
- To avoid card pop from the card slot and hurt your eyes, please press and move card lightly.

Non Waterproof

The device is non waterproof. Please keep it away from any liquid. In case it happens, remove the battery immediately, dry the surface and send the device to our service center for checking. Do not try to turn on the device by yourself.

Battery & Earphone

- Please remove the battery to avoid leakage and damage to the

device whenever the device will not be used over an extended period of time.

- Use the rechargeable battery and the power adaptor that come with this device only.
- To maximize the life of the rechargeable battery, please recharge only when power is off.
- Avoid any contact of two poles of the battery and keep away from fire.
- In order to prevent your hearing from being damaged, we suggest that you should adjust volume to the security, suitable size and not use the earphone continuously with big volume.

Magnetism

This device is magnetic. Please do not place it close to any equipment that applies with magnetism theory so as to avoid demagnetization.

Note:

- ① ***Any damage caused by the above reasons is not covered by warranty.***
- ② ***In case the unit is disconnected with PC, if you shut off and power on in 10 minutes, the screen before you shut off will be preserved, otherwise it will come to the standard menu.***



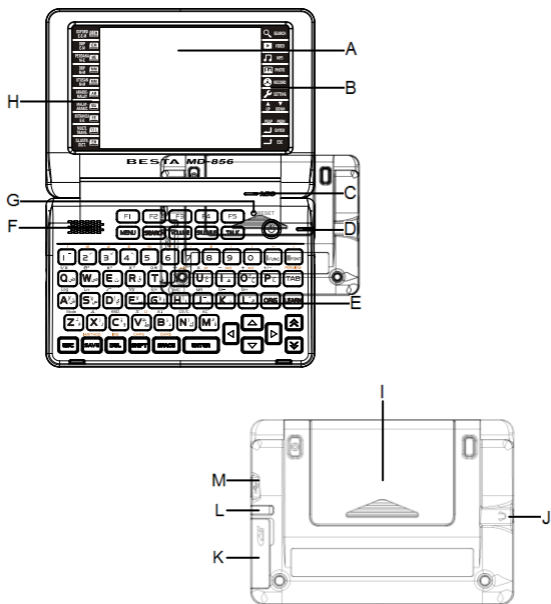







2.Product Layout













A	Screen	Adopts 3.5 inch TFT screen with touch panel. The screen may crack if the device falls on the ground. Rub the screen lightly with a dry and soft cloth, Do not use any volatile liquids.
B & H	Tablet key (Right & Left)	Tap to open shortcut function.
C	Microphone	Record the voice and your pronunciation.
D	LED indicator	Different colors of LED indicator show you the different situations of power: green light ---> No battery or battery full recharged, red light ---> Power is recharging with battery
E	Keyboard	Includes function key, letter key and numeric key.
F	Speaker	Please don't turn up the volume to disturb others' work and study.
G	RESET key	Reset the device.
I	Battery cover	Remove the battery cover to insert or remove the Battery.
J	Earphone	The sound volume of the earphone should be not too high so as not to injure your hearing.
K	SD/SDHC Slot	Insert the SD /SDHC Card into the card slot. Turn the product off before removing/inserting the card. Otherwise, the memory of the product may be lost and the card may be damaged.
L	Stylus	Use the stylus which comes with this device only. To avoid scratching on the screen, do not use any other pointed objects such as pencils or pens.
M	USB slot	Connect with PC by USB cable to transmit data; Connect with adaptor by USB cable to recharging the device. Make sure transmission of the data is finish, then tap  on PC to remove the USB safely, tap [ESC] in device to escape from function window of "SYS—PC Link".

3. Tablet Key

Tap with stylus to activate the functions.

	: Oxford English-Malay Dictionary
	: DBP English-Malay Dictionary
	: Perdana Malay-English Dictionary
	: DBP Malay-Malay Dictionary
	: Utusan Malay-Malay Dictionary
	: Arabic-Malay Dictionary
	: Malay-Arabic Dictionary
	: Britannica Concise Encyclopedia
	: Multi-Language Dictionary
	: Illustrated Dictionary

	: Search Engine
	: Video Learning
	: MP3
	: Photo
	: Digital Recorder
	: Set Volume/Speed/Brightness/Mute
	: Function as the Up/Down key
	: Function as the Page Up/Down key
	: Function as [ENTER]
	: Function as [ESC]

4.Keyboard

Function Key

『 RESET 』	<ul style="list-style-type: none">•Reset key
『 ON/OFF 』	<ul style="list-style-type: none">•Turn ON/OFF the device
『 F1~F5 』	<ul style="list-style-type: none">•Select corresponding function main menu•Function keys, the same as [F1]-[F5] on the screen
『 MENU 』	<ul style="list-style-type: none">•Directly return to the main menu•Switch and view the different types of the main menu with [SHIFT] key
『 SEARCH 』	<ul style="list-style-type: none">•Open the “Search Engine” screen•Search the words/phrases/all of the keyword in the explanation screen•Access the search screen of “Expense, Course ” in PIM; access multi-dictionaries search screen except above
『 VOLUME 』	<ul style="list-style-type: none">•Set volume, speed of voice and brightness of screen and Mute.
『 SYLLABLE 』	<ul style="list-style-type: none">•Pronounce syllable by syllable for multi-syllable of English words
『 TALK 』	<ul style="list-style-type: none">•Tap to listen the pronunciation of the words.
『 I FUNC 』	<ul style="list-style-type: none">•Select item “I” in the menu or index screen•Same as [FUNC] in screen•With [SHIFT] key to input symbol “-” in Chinese input mode; input hyphen in English input mode; input long tone in Japanese input mode
『 II FONT 』	<ul style="list-style-type: none">•Select item “II” in the menu or index screen•Switch font size of the devices•With [SHIFT] key to input symbol “.” in English input mode; input space mark in Japanese input

	mode; input decimal point in calculation
『TAB』	<ul style="list-style-type: none"> •Switch focus in some screens •Open/close preview screen in index screen of dictionaries
『ORG』	<ul style="list-style-type: none"> •Return to the original inputting screen
『LEARN』	<ul style="list-style-type: none"> •Open the read after the device function •Open the repeat function with [SHIFT] key
『ESC』	<ul style="list-style-type: none"> •Exit from the current function and return to the previous screen
『SAVE』	<ul style="list-style-type: none"> •Save the messages; Save items in the explanation screen of some dictionaries for “Listening and Learning” and “Revision” •Open the list of input method with [SHIFT] key
『DEL』	<ul style="list-style-type: none"> •Delete a letter or selected string/ items, same as [Del] in screen •Switch the editing mode with [SHIFT] key
『SHIFT』	<ul style="list-style-type: none"> •Combine with other keys •Temporarily lock the keyboard for inputting capital letters •Press twice to lock the keyboard for inputting capital letters
『SPACE』	<ul style="list-style-type: none"> •Input a space •The light tone of Chinese Pinyin input method •Confirm the first choice when inputting Chinese •Input symbols with [SHIFT] key
『ENTER』	<ul style="list-style-type: none"> •Confirm the current action •Move the cursor to the next line to input data •Mathematical sign: equal to [=] to calculate result
△ ▷ ▽ ◀	<ul style="list-style-type: none"> •Up direction key: Move the cursor up or scroll a line up

	<ul style="list-style-type: none"> •Down direction key: Move the cursor down or scroll a line down •Left direction key: Move the cursor left or page left •Right direction key: Move the cursor right or page right
	<ul style="list-style-type: none"> •Page up: View the previous data •Page down: View the next data

Numeric Keys

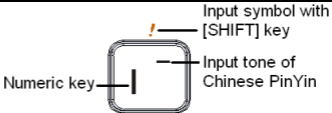
『0~9』	
-------	---

Letter keys 『A~Z』

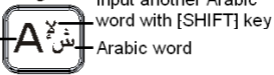
<p>Mathematical sign — Log</p> <p>English letter — A</p>	
--	---

Notes:

When there are two Korean Pinyin in one key, for example letter key “Q”, press it to input Korean Pinyin “ㄱ”. Input the other Korean Pinyin “ㅋ” with [SHIFT] key.

5. Accessories specification and use

Accessories Specification Table

Name	Specification
Panel	3.5 inch TFT screen
Battery	Rechargeable lithium battery: 3.7V/700mAh

USB cable	USB cable (charge and connect with PC)
Adaptor	DC5V/1A (charge and function as power source)
SD card slot	Accepting micro SD/SDHC card
Stylus	Come with the cover of device

6. Power source

One of the following power sources can be used:

- ① Rechargeable lithium battery that comes with this device (3.7V/700mAh).
- ② A power adaptor with DC output 5V/1A that comes with this device. This power source can be combined with option ①.

6.1 How to Install/ Replace the Battery

Insert: (Turn off the power)

- ① Remove the battery compartment cover.
- ② Insert the battery into the compartment.
- ③ Close the battery cover securely.

Remove:

Press [ON/OFF] to turn off the power.
Then please remove the battery as
Instruction.



Note:

- ① *When the power is insufficient, please insert the USB cable or power adaptor to recharge the battery.*
- ② *The power is insufficient when just charged, this means the battery is no longer usable. Please get a new one.*
- ③ *Personal data will be retained even if the device is out of power. Please turn the device off first, and then take out the battery 3 seconds later. Otherwise, data may be displayed incorrectly.*

6.2 Recharge the Battery

If you are the first time to use the device, please recharging battery first.

- ① Connect the device and PC with USB cable.
- ② Connect the device and power supply with the adaptor. One end is inserted in the USB slot, the other is inserted in the electrical outlet.



7.Menuus

Main Menu:



	Switch five sorts selection districts
	Tap to choose the input method
	Inputting area
	Tap to search
	Tap to page up/down
	Time
	Check the battery power
	Allow to download data

Index Screen:

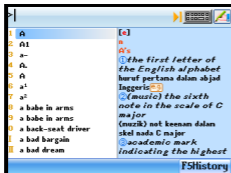

Index menu:

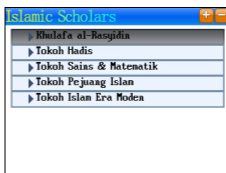

Explanation Screen:

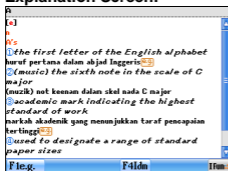

Indicator of menus:

	Data searching...
	Corresponding input methods(can switch)
	Tap to access handwriting recognition
	Tap to access Soft Keyboard of some input method
	Example sentence or example sentence searching
	The number of the layer of Multi-layered Search
	Association input method
	Pronunciation
	Unfold/fold the index menu

8.Input Methods

The device provides several input methods; you can tap the indication symbol  to switch the input methods.

- Press [SHIFT] then press [SAVE] to display the input methods for select;
- Press [SHIFT] then press [SPACE] to open the symbol input method;



English	English Keyboard
Smart Pinyin	EngHandwriting
Chinese Pinyin	Symbol
CHN Symbol	Symbol Keyboard
CHN Symbol ...	Arabic
Wu Bi	Roman Hiragana
ChaHandwriting	Roman Katakana
Radical Strokes	Hiragana
Total Strokes	Katakana

8.1Input by keyboard

Please refer to the introduction of keyboard to input corresponding PinYin, Stroke and symbols. Take the input method of smart Pinyin for example:

Phrase Pinyin input

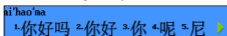

Initial letter recognition

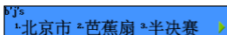

Input the symbols

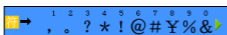

Press numeric key to choose the words and symbols.

Press left/right direction key to page up/down and view the words and symbols.

Association input method



8.2 Input by soft keyboard

Input words according to the corresponding soft keyboard in the screen. Take the Vietnamese soft keyboard for example:



Note:

When the color of button is gray, it said that the function of the button is unavailable.

8.3 Handwriting recognition

- Tap to access handwriting recognition of some input methods.
- Tap to switch to English/Chinese /Japanese/Korea input.
- Tap to switch to corresponding soft keyboard.
- Tap to open the on-screen symbol keyboard.
- Tap to return to the keyboard input mode.
- Tap to switch the single/double/full window for handwriting.
- Tap to switch the single character recognition/multi character recognition under the writing mode of full screen.

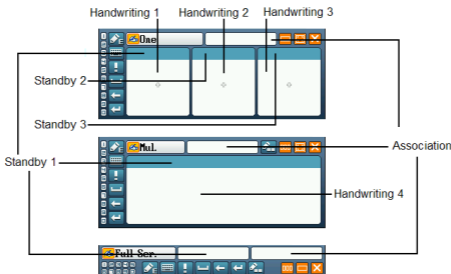

Note:

- *Please don't write in the function area when you use the full screen multiple handwriting.*
- *Keyboard input is also available when handwriting is used.*
- *Handwrite pen up time can be set in <SYS--Handwriting Setting>.*

9.Download operation

You can download study and multi-media data. Please operate as follows:

9.1Download data from PC Link

Please follow the steps below, download data into device via PC Service Home.

- ① Insert CD-ROM into PC and install PC Service Home.
- ② Connect the device and PC via USB cable. The device and PC will be linked automatically.
- ③ Open PC Service Home; select "Media Download" to enter into the download function; choose "Download Classification" and fix the data desired; tap "Download" in the toolbar; download the selected data to the default folder.
- ④ Enter "SYS-File Management " and find the default folder.

9.2Copy to device

Connect the device and PC via USB cable. The device and PC will be linked automatically. Users are allowed to copy data to the device.



- ① Enter "SYS-File Management", create new folder under root directory of the device or the card.
- ② Connect PC and device via USB cable. The device and PC will be linked automatically.
- ③ Copy data directly from PC to the newly-created folder.
- ④ Press [ESC] to quit "SYS-PC Link", enter corresponding functions to read the downloaded data.

Dictionary Series

Dictionary summary

Index screen

- Press [Tab] to open/close preview window. (It is unavailable when you open the phonetic symbol input method)
- Input words for search and press [ENTER] to enter the explanation screen.
- Press Page Up/Down key to look through the words.
- Press Up/Down key to select words.
- Press [SHIFT] and Page Up/Down key to see the first/last page of the index.

Explanation screen

- Press Page Up/Down key to look up the previous/next explanation.
- Press [SHIFT] and Page Up/Down key to see the previous/next page of one word's explanation.
- Press [ESC] to back to the previous screen.

1.Dictionary Index

After dictionary function is accessed, the index screen of all entries will appear first. In this screen, you can press the Page Up/Down key for search or input words to search the explanations.

- In index screen, directly input the words to search.
- Tap  or press [TAB] to switch single/double windows.
- Press [FONT] to switch 3 kinds of font sizes.
- Press [SHIFT] key with page up/down key to go to the first page or last page of index screen.
- Press [ENTER] key to view the explanation screen.
- Press [ESC] to return to the preview screen.
- Secondary search and wildcard search are not available in some dictionaries. Please refer to the introduction of "Searching Data".

1.1History

Tap or press [F5History] to view the words that have been looked up recently (Up to 200 words can be recorded). Press [DEL] to delete the records one by one.

1.2 Language Selection

Tap [F1Language] to select a corresponding language when several languages are provided.

e.g., Multi-Language Dictionary

1.3 Copyright

Tap [F4Copyright] to view the copyright of the dictionary.

2.Dictionary Explanation

- Input words to be looked up and access the explanation screen.
 - Provides multi-dictionaries for all dictionaries.
 - Press the Page Up/Down key to look up the previous/next explanation.
 - Press [SHIFT] first, and then press the Page Up/Down key to view the explanation of the current word on the previous/next page.
 - Provides pronunciation of explanations.
 - 3 kinds of font sizes can be switched,
 - Can cross search, search in multi-dictionaries for the selected words, the cross search layer up to 30.
- <Some dictionaries will provide following function>:
- Provides vowel of phonetic marked symbols, and provides syllable pronunciation for English words.
 - Provides repetition and reading after the device for practice.
 - Provides correction function, provides comparison of standard pronunciation and users' pronunciation.
 - Provides example sentences for reference.

2.1 Saving Data

Press [SAVE] to save words in some dictionaries for "Listening and Learning" and "Revision". You can study the words which saved in "Listening and Learning" and "Revision".

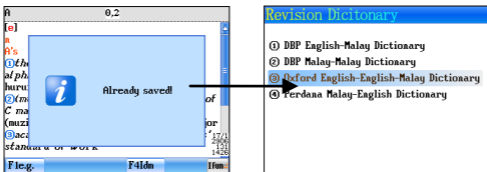

2.2 Repetition & Read after the Device

In the explanation screen of some dictionaries, provides repetition and read after the device function for words. Press [Learn] once to provide the function of read after device for words. Press [SHIFT] once, and then press [Learn] once, the device will repeat the current headwords, you also can set the repeat time in "Sound Setting".

2.3 Pronounce words word by word

The device can pronounce Chinese words word by word, it makes you easy to learn pronunciation of words. Please set the function in the "Sound Setting".

"Visual Speech" of Chinese Words in index screen

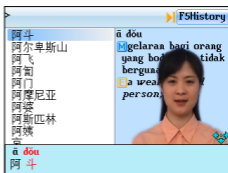

"Visual Speech" of Chinese Words in explanation screen

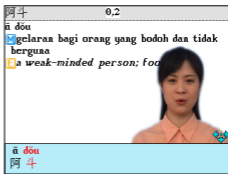

Notes:

- ◆/◆/◆/◆ key show the moving scope of the portrait of screen,
- ◆/◆ key to move the position of the portrait, ◆ key show moving the portrait to the downside of screen to close the caption, ◆ key show opening the caption.

2.4 Correction

Device provides correction function for words, the correction function will compare the standard pronunciation with the recorded users' pronunciation, it will help users rectify their pronunciation.

Tap [Correction] to access to the correction function screen

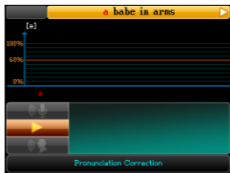

- Tap  to listen to the standard pronunciation of device.
- Device will record the users' pronunciation.
- Compare the standard pronunciation with the recorded users' pronunciation, and then show the result of comparison.

3.Searching Data

Provides several search methods to help users.

index screen:

- 1.Smart input search
- 2.Wildcard search
- 3.Cross search
- 4.Secondary search

explanation screen:

- 1.Multi-layered search
- 2.Other data search
- 3.Search Engine

3.1Smart Input Search

Just input the first one or several letters, you can find the desired words or phrases.

There are 3 kinds of methods:

- ① Input the first or first several letters of a word, or mark a word to be looked up, and then press [ENTER] to confirm.
- ② As for Chinese character, input the first one or several Chinese characters to be looked up, and then press [ENTER] to confirm.
- ③ Double tap the word or character to search.

3.2Wildcard Search

To look up a word that you are not sure of spelling, input all the letters or characters you know, and then replace the unknown letters or characters with "?" or "*".

Steps:

- ① Input the letters or characters that you are sure of.
- ② Input unknown letters or characters with "?" or "*".
- ③ Press [ENTER], the list of words matching with your input will be

displayed.

- Press the Page Up/Down key to look up.
 - Press the Up/Down key to move the cursor to select words.
- ④ Double tap the word or character or press [ENTER] to search.

Notes:

"?" stands for an unknown letter; "" stands for a string of unknown letters.*

3.3 Cross Search

When the current dictionary does not contain the word or character you want to look up, the device will transfer to other dictionaries. If the word or character is available in other dictionaries, it will display the explanation.

3.4 Secondary Search

If the word you input is not found, please check your spelling, or that this words not covered in this dictionary. The device will provide 2 kinds of searching methods and 1 recording method:

Spelling Check -- displays the list of words similar in spelling.

The Nearest Word -- displays the nearest word in order.

Add New Word -- add the unfound word into DIY Dictionary.

Steps:

- ① Input word, then press [ENTER] to search.
- ② Press the corresponding numeric keys to select word to search.
 - If "Spelling Check" is selected, press the Up/Down key to select the desired word, and then press [ENTER] to confirm.
 - If "The Nearest Word" is selected, it will display the explanation of the nearest word.
 - If "Add New Word" is selected, you can add the word into DIY Dictionary.

3.5 Multi-layered Search (Search in the Explanation Screen)

Multi-layered Search led you cross search the unfamiliar words or phrases. Please choose the words, then open other Dictionaries to search. The number of the layer will be displayed at the top right corner.

- ① On the explanation screen, highlight the character(s) or word(s) to be looked up.
- ② Press [ENTER] to search or press [F1], [F2], [F5] to search in the

corresponding dictionaries.

- [F1] and [F2] provide search in the commonly used dictionaries. [F5] is the word bank. The function of [F1] is the same as that of [ENTER].

③ Press [ESC] to return to the previous screen.

4. Search Engine

Search Engine can search for the input data accurately and efficiently. it provides 3 searching categories of Dictionary/Data/MULTI to select, you also can set searching scale when you select the searching category.

- Select and switch the searching categories of Dictionary/ Data/MULTI.
- When select category of Dictionary, you can set searching scale of Words/Phrases/All. Press [F5Setting] to select the dictionaries which you want to search for.
- When select category of MULTI, you can set searching scale of Video/Audio/ Photo, you also can input the extension file name to search.
- Press [Search] or press [ENTER] to the result of searching.

e.g., searching for the Phrases of the word "calm".

Select category of Dictionary, and set searching scale of Phrases, then input "calm" and press [Search]

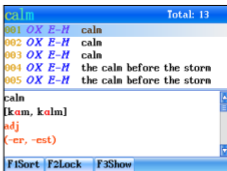

e.g., searching for the data with extension file name of ".bmp".

Select category of MULTI, and set searching scale of Photo, then input ".bmp" and press [Search]



result of search



Press [Search] key to open Search Engine in the screen of index and explanation:

Input word in index screen of dictionary, and press [Search]

Highlight the words which you want to search, tap [F5Search]

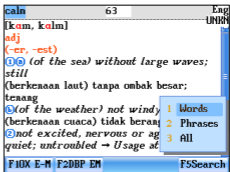

Study Series

1. Dialogue and Conversation series

1.1 Classification

Provides classified dialogues for practice.

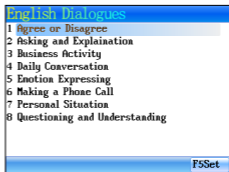

1.2 Pronunciation

- Pronounces sentences in different languages for your practice.
- Press Pronunciation key [TALK] to listen to the pronunciation.
- Press  or numeric key to pronounce the corresponding sentence.
- Press [Play] to read all the sentences successively.

1.3 Cross search

Provides cross search function of dialogues. Check "Cross Search" for details.

1.4 Search

Provides function of key words searching. It makes you easy to find the sentences which content the key words.

Choose [F5Search] and input keyword

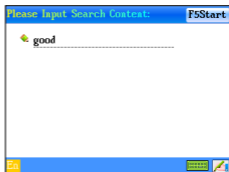

Choose [F5Start], the red line will mark the searched word, press [F4Continue] to go on searching.

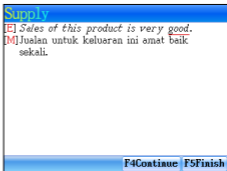

2.English study series

Improve your English via practice in listening, reading, grammar, pronunciation and spelling.

2.1Practice

2.1.1Choose the right answer

You can tap the screen and choose the right answer for the questions.

2.1.2Revision

Provides several word banks for your revision, you can revise words by steps of learn, revise & test, recall and practice, you also can set the group, revision mode.

2.1.3 Make sentence

You can use the stylu to tow the words to make a sentence.

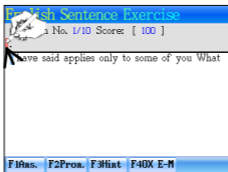

2.1.4 Writing

Provides the function to help you to write the bussiness letter.

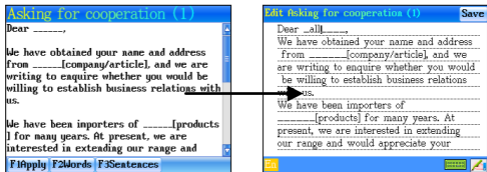

You can write the letter in edit screen, and tap [Save] key to save the letter. You can view the saved letter by tapping the [F2Open Letter].

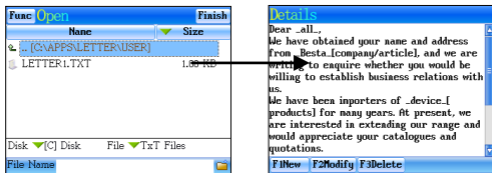

3. Pronunciation series

Provides introduction of English Phonetic Symbols, Korean Phonetic Symbols, Japanese Fifty Phonetic Symbols, Malay Phonetic Symbols.

Phonetic Symbol Demo

Fifty Phonemes F5General Table

あ	か	さ	た	な	は	ま	や	ら	わ	ん	濁	半	拗	促
あ	ア	a	:	あい(1)	愛	1	☞							
い	イ	i	:	いゑ(2)	家	2	☞							
う	ウ	u	:			3	☞							
え	エ	e	:			4	☞							
お	オ	o	:			5	☞							
か	カ	ka	:			6	☞							
き	キ	ki	:			7	☞							

F1Pron ☞ F2Deno 🗿 F3Stress F4Stroke

Stroke of symbol

Hiragana F5Katakana 1/3



F1Demo F4Next

Example of Phonetic Symbol

Pronunciation Rules of Malay

	b	c	d	f	g	gh	h	j
a	ba	ca	da	fa	ga	gha	ha	ja
e	be	ce	de	fe	ge	ghe	he	je
é	bé	cé				ghé	hé	jé
i	bi	ci	baca			ghi	hi	ji
o	bo	co	bara			gho	ho	jo
u	bu	cu	bahaya			ghu	hu	ju
ai	bai	cai	dai	fai	gai	ghai	hai	jai
au	bau	cau	dau	fau	gau	ghau	hau	jau
oi	boi	coi	dai	foi	goi	ghoi	hoi	joi

F2Linking ▶

4. Grammar series

Provides grammar series introduction to help you quickly master the vocabularies, phrases and usages.

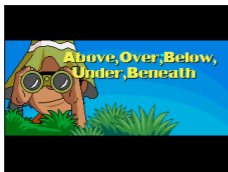

Malay Learning

- 1 Malay Grammar
- 2 Malay Proverb
- 3 Malay Simile
- 4 Malay Idiom
- 5 Malay Thesaurus
- 6 Malay Abbreviation

5.Chinese Learning

Provides study of stroke, radical, character structure, PinYin to enhance your Chinese.

Strokes

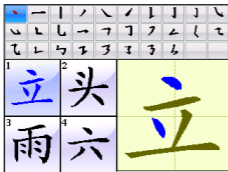

Radicals

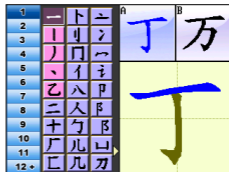

Characters

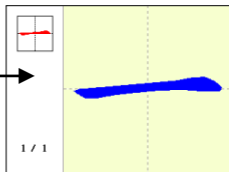
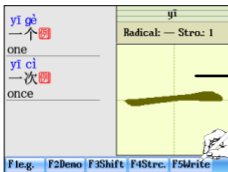

PinYin

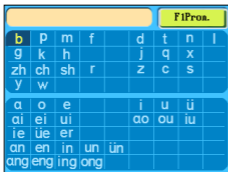

Characters structure



Multi Series

1.MP3

Simulate playing and A-B record playing



- Tap / / to switch to Lyric List/Skin List/Play List. Tap to show two types skins of MP3 for users to select.
- Tap to select language of lyric.
- Tap to open song list and select songs.
- Tap to select order of playing.
- Tap / to open/close the repetitive playing state.
- Tap / to set bit/stop bit, and / will be played when you are setting.
- After setting, the device will play the section between and .
- When pause or stop, the lyrics can be cross searched.
- Tap or press [G] to close the window of MP3. Tap [ESC] to close the MP3 screen when MP3 keep playing, you can tap MP3 key in touch panel to open the MP3 mini screen.

2.Photo

Image browse screen, tap [F1] to search images, tap [F3] to shift display format of files.



Tap direction key to choose and view the photo by full screen, tap screen of viewing photo to open the function select menu.



 : Change color of plate

 : Enlarge photo to fit/best fit

 : Previous/next image

 : Anticlockwise/clockwise rotate

 : Flip horizontally

 : Check file name

 : Magnify/Minify photo

 : Slide show the image

 : Slide showing setting

3.Text Editor

Click [Option] to open the drop-down menu:

- New - create a new .txt document.
- Open File - open a document that has been created.
- Save - save the current document.
- Save As - save the current document to other formats, names, or save it under another path.
- Edit - go to the line of the document.
- Find - find keywords in the document, click button to see the next search result.
- Setting - includes font setting, autosave setting, code type setting, HEX mode setting.
- Switch to read mode / switch to edit mode - to switch the document to read / edit mode.
- Mark - tap [Mark] to fix the cursor, and press Left/Right key to set the range. Tap [Relax] to cancel.

-  -- cut
-  -- copy
-  -- paste

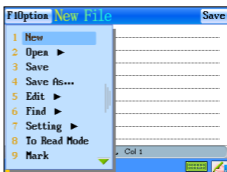

PIM Series

1.Data Input

Input data in the corresponding fields of Class Schedule and Income & Expense with provided or downloaded input method.

Input data in the fields:

- Tap the corresponding input method to input data.
- Tap ▼ to open the drop-down menu.
- Press the Up/Down key to scroll up/down.
- Press the Page Up/Down key to view on the previous/ next page.
- Press [ENTER] to start from a new line.
- Tap or press [SAVE] to save data.
- Press [ESC] to close the window after selecting the corresponding item.

2.Data Index

If there is saved data, the index will appear when the function is accessed. You can delete or lock data on index screen.

Class Schedule: Index screen is not available. Tap the course directly to view the details.

3.Detail View

You can view the details of data, and modify, copy and delete data. Besides, words can be cross searched in corresponding dictionaries.

Tool Series

1. World Time

- ① Provides date and time display for local city as well as others.
- ② Provides local city, date, time and daylight-saving time (DST) settings.
 - Tap time/date/city name on the screen to set.
- ③ Provides timer function.



2. Paint Brush

- ① Provides 12 tools and 41 functions.
- ② Provides 14 functions bars.
- ③ Provides 65,536 colors.

3. Calculator and Conversion

- ① Provides calculator, Scientific Calculator.
- ② Provides conversion for length, temperature, volume, area, heat, capacity, power, weight and pressure.
- ③ Provides conversation function and exchange rate setting.

System Series

1.PC Link

Connect the device with PC via PCLink cable, and then you can transmit data. There will be a message indicating the current connection status during and after transmission.

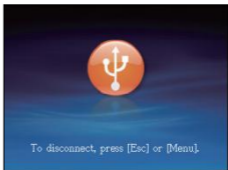

While connecting:

- !! Please do not interrupt, otherwise data may be lost.
Please make sure there is enough power or the adapter is inserted.
- !! Before pulling out the USB connecting line, please uninstall the USB device safely.

2.File Management

This function allows to transmit data between card and the device. You can create new folder or rename folder.

Open the top path

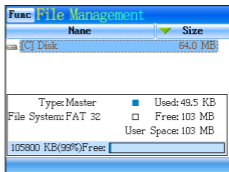

Press [ENTER] to access the selected disk

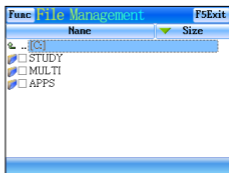

2.1 Creating New Folder

- ① Open the path in which you want to create new folder, and tap [Func] to select "New Folder".
- ② The default name of new folder is "MYDIR". Input new name and then press [ENTER] to confirm.

Creating new folder

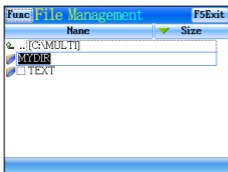

Copy data to device from card

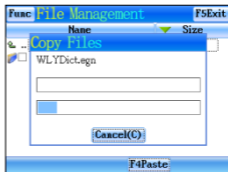

2.2 Rename

- ① Choose your desired file, and then tap [Func] to select "Rename".
- ② Input new file name, and then press [ENTER] to confirm.

2.3 Putting Folders in Order

- Tap "▼" to select item, as which the folders will put in order.
- Tap "Name" to put folders in the order, which will be marked by "▲▼".

2.4 Format

Select disk or file to format

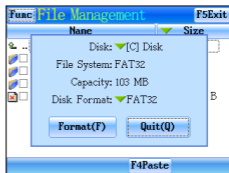

Notes:

Please select the disk format as FAT32 when the Micro SD card is over 64MB.

Content of CD

The attached CD-ROM provides PC Service Home. Insert the CD-ROM into the CD driver disk of PC, select "Setup" to install program.



Note:

- *For Windows2000 users, please access super administrator (Administrator) to log in.*
- *For Windows2000 users, we suggest you install Windows2000 Service Pack 3 program provided by Microsoft. If Service Pack 3 is installed, you don't have to install USB driver program. Please select "USB Driver readme" in picture 1 to follow the instructions to install.*
- *For Windows XP users, we suggest you install Windows XP Service Pack 2 program provided by Microsoft.*

1.PC Service Home Installation

PC Service Home provides ten functions: Media Download, Backup and Restore, CD Express, Open U-Disk, Service Toolkit, International Download, DIY Dictionary and Settings. They all have these following characteristics:

- Download multimedia files like films, pictures and eBooks.
- Backup and restore data.
- Share data with PC and the device.

- Provides tools which can convert the media file on PC into .avi that used only in our device.

1.1 Software & Hardware Requirements before Installation

You need to install PC Service Home program into your PC. The following are the system requirements:

- Vietnamese Windows 2000/XP/VISTA/ Windows 7 operation system
- CPU: Pentium (R) III 1GHz or better
- LCD: VGA 800*600 or better, which is supported by Microsoft Windows
- Version 5.5 of Microsoft Internet Explorer or above
- Minimum 800MB of hard disk
- CD-ROM Driver
- (Sound Blaster compatibility) sound effect card (driver properly installed)

1.2 Installation

- ① Insert the CD into the CD driver of PC, and then click "Setup" to start installation.
- ② Access the welcome menu, and then click "Next".
- ③ Click "Browse..." to select file folder of destination in picture
- ④ Click "OK" to confirm the selection.
- ⑤ Click "Next" to select setup type.
- ⑥ Click "Next" to access program folder naming menu. Click "Next" to continue.
- ⑦ The Install Shield Wizard begins to install EBook Editor to your computer.
- ⑧ After installation is completed, click "Yes" or "No" to select whether to restart computer now (we suggest users restart PC), and then click "Finish" to end.

Note:

To uninstall PC Service Home program, please access "Control Panel"→ "Add/Remove Programs". (Also can from "Programs"→ "PC Service Home"→ Uninstall PC Service Home).

1.3 Opening the Program

Click "Start" menu→ "All Programs"→ "PC Service Home"→ "PC Service Home 2.0" or double click the shortcut  in desktop to open.



Note:

To optimize PC Service Home display, please use standard font type in Windows.

1.4 Function and operation

1.4.1 Media Download

Media download provides the function of downloading the programs , musics, e-books from PC.

- ① Use USB cable to connect the PC and device, and then device enter the function window of "SYS--PC Link" automatically.
- ② Open the PC Service Home program, choose the "Media Download" in the main menu to access to the operation screen, select "MP3" in the "Category list", and click the titles which you want to download, then click "Download" button in the tool bar, device will auto to download the titles to the default directory of device. You also can click the "Preview Media" to preview the MP3 which you want to download.
- ③ After finish download, please enter the "SYS--File Management" to find the downloaded titles by the default directory PC Service Home.

1.4.2 Backup and Restore

Backup all the data of electronic dictionary into PC; Restore the backup data from PC into electronic dictionary.

Click "Backup and Restore" to access to the function screen. When you choose "Backup Unit Data", you will find a new file open dialog, you could select the path where you'd like to keep the backup file and input file name (*.BBK), then click "Save" to backup files. When you choose "Restore Unit Data", choose the files which you want to

restore, the click "open" to restore files.

1.4.3CD Express

Allows to transfer music in CD-ROM in the form of MP3 directly to your device.

1.4.4Open U-Disk

Allows to move, copy, delete or append file folder.





1.4.5 Service ToolKit

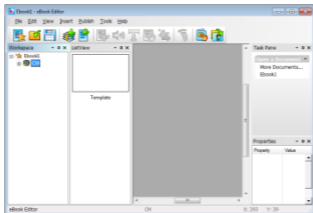







a EbEditor

EbEditor is software combined with text, sound and pictures. You can make a vivid and interesting eBook or e-card by using the eBook editor to edit animated cartoons or pictures in the CD/website. The eBook Editor supports 16 colors and color pictures. Click "Service Toolkit"-- "EbEditor" in PC Service Home to access the eBook editor screen.





Workplace, list View, Task Pane and Properties is opening status by system default, and users can set it to be open or closed in "View" of menu bar.

- : Create a new project. In the eBook Editor Screen, click icon  in the top left of the tool bar. input "Project Name" (You can name it by yourself) , and select the model platform , then click "OK" to create the new project.
- : Open an existed project.
- : Save the current project.
- : Add a new CM (section) in the index of a project.

- : Append a page in the current CM (section).
- : Add picture or animated cartoon in the current CM. When you open the screen of "Insert Image and Setting", you could set back color of the file, you could use "Use System Image Library" to choose and insert the image to the file, you also could set the moving length, moving direction and moving step of the image.
- : Add MP3 file in the current CM. Click "System library" in "Vocal Setting" to select an MP3 file (16kbps-320kbps) from the list. You also can set play time, start time and so on.
- : Add text in the current CM. You can set font type and effect in the "Text Editing" screen.
- : Play eBook with special effect.
- : You may use macro to optimize your eBook. For definition about macro, variable, function, please click "Help" menu→ "Content" to view "Advanced functions of eBook Editor" of "Make your own eBook"→ "Using Macro to optimize your eBook".
- : Convert BMP, JPG file into HCB file (A special file format for eBook Editor)
- : You can set path in which the image or text is moved. Direction of the movement depends on the number you marked. You can set speed and length of the step for the moving path.

b Video Converter

Video Converter is an easy film converting tool. It can convert the common media (mpg, mpeg, avi, dat, rm, rmv, mov, mp4, vob, asf, flv, 3gp) into avi file that can play in the electronic dictionary and PC.

- ① Open Video Converter.
- ② Click  to select the files which need to be converted, then click "OK".
- ③ Tap [Browse] to browse the folder of output files, default path of SYS is: C:\MY video.
- ④ Tap  begin to convert to a .avi format file. After finish converting, escape from the display frame, there will be a mention is "Conversion Finish".

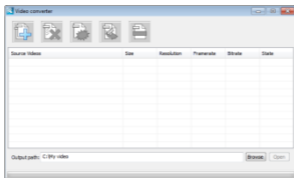

Tool bar:



: Add the media files which need to be converted.



: Delete the files which you selected.



: Delete the files in the file list.



: Begin to convert files.



: Stop to convert files.

1.4.6 DIY Dictionary

Input the content of DIY Dictionary of the device, and add or modify content.

1.4.7 Settings

Set "ADS Center, ADS Check, Media Download and System Settings" respectively. Tap "Settings" in the main menu of PC Service Home, and then tap "ADS Check" to set.